

# Multifuser DC3

Installation Manual

EN

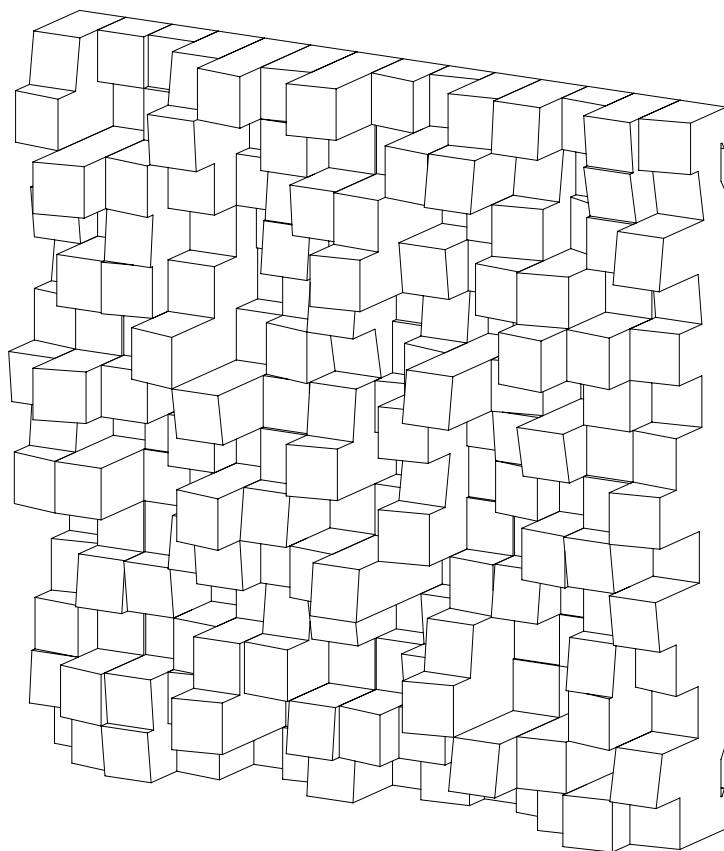

✓ MATERIAL NEEDED

Included

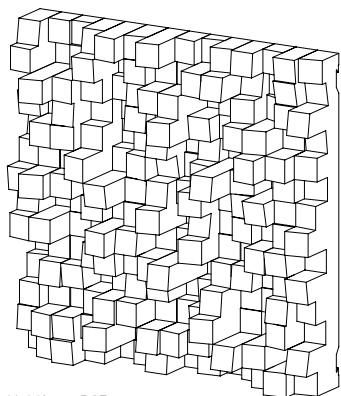

Multifuser DC3

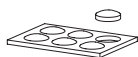

Silicone Drop



VicFix Mini

Not Included

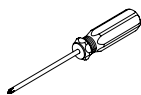

6mm Phillips Screwdriver



Measuring Tape



Wall Plugs and Screws

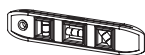

Level



Drill

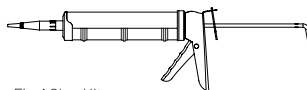

Flexi Glue Ultra

This product can be installed on the wall with VicFix Mini and on the ceiling using Flexi Glue Ultra (not supplied).

**Wall Installation**

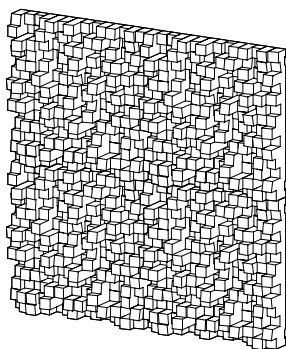

**Ceiling Installation**

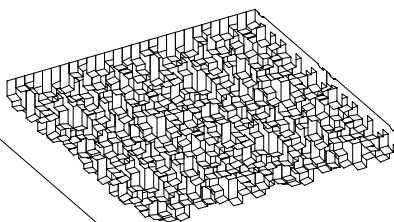

# Ways of using the gauge

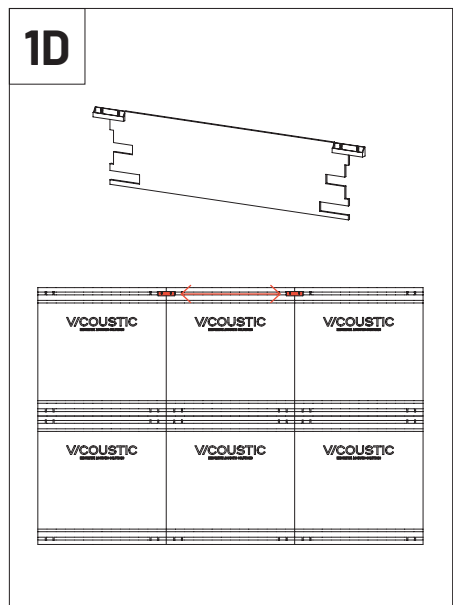
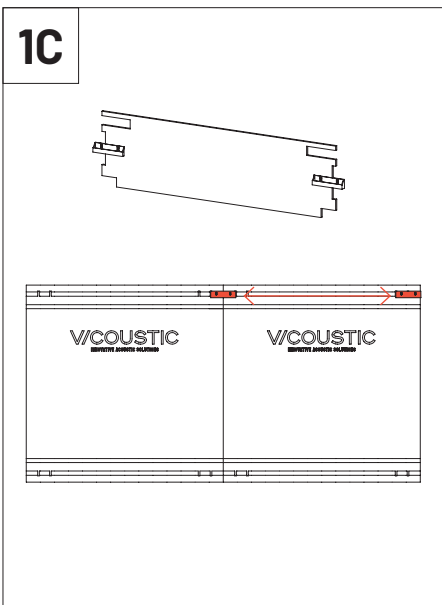
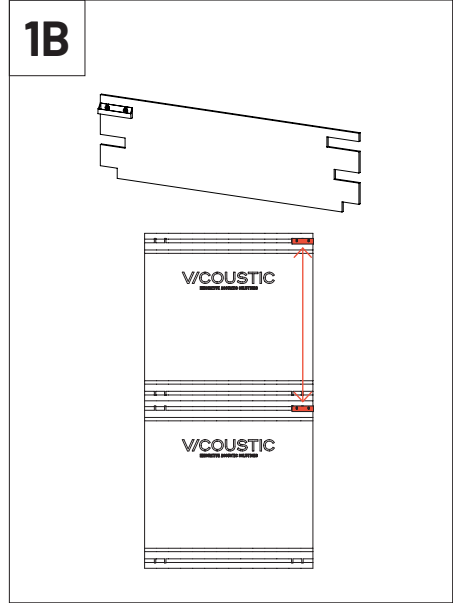
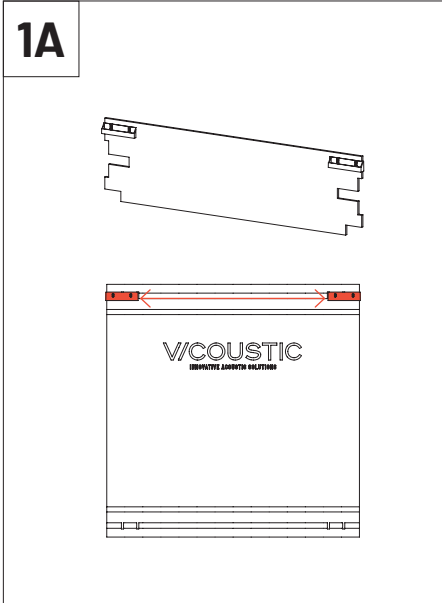

## 2

### Wall installation - One panel

After defining the place where you want to install the panels, start marking the position of the Multifuser DC3 fixation clips.

! This product can also be installed using Flexi Glue Ultra.

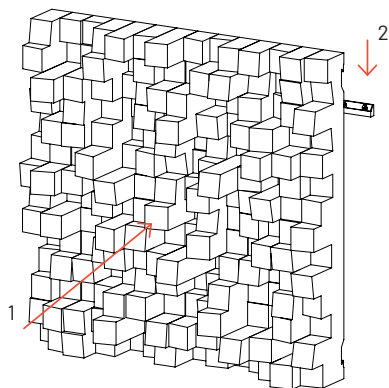
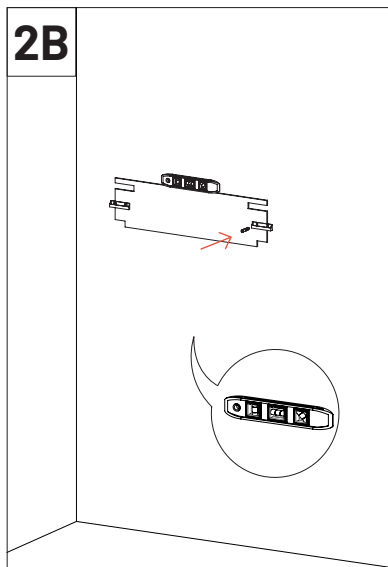
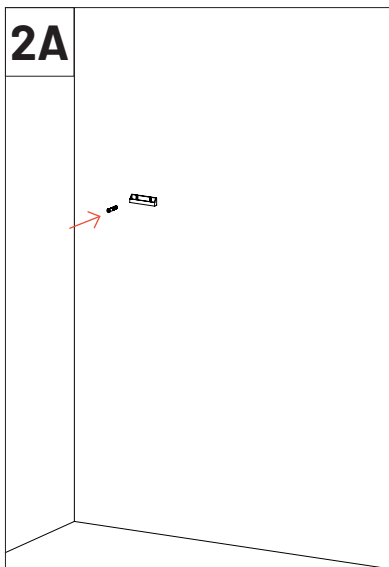

# 3

## Wall installation - Installation up to three panels

Define the place where you want to install the panels and fix the First VicFix Mini. From there and with the help of the gauge provided, mark the positioning of the remaining fixation clips.

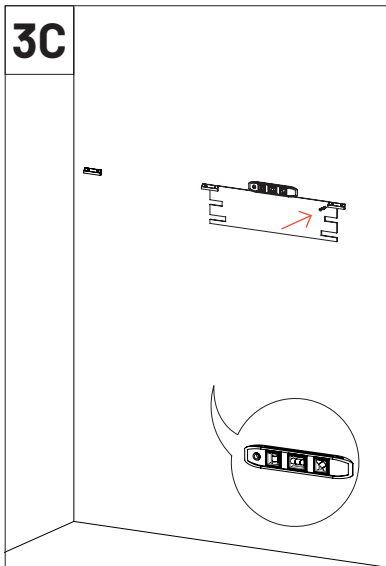
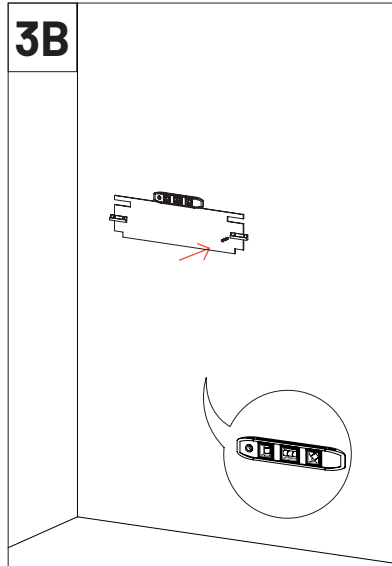
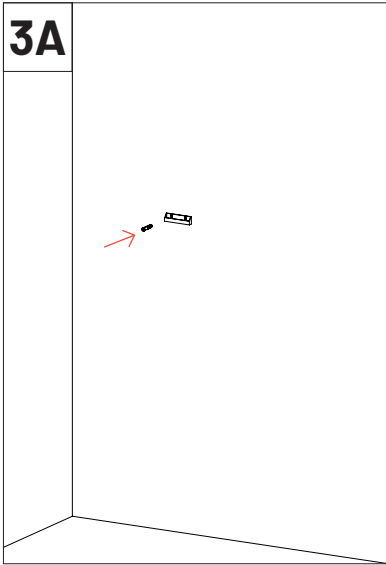

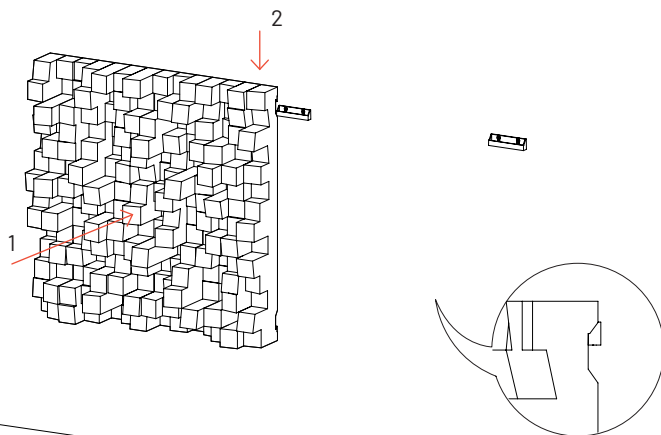
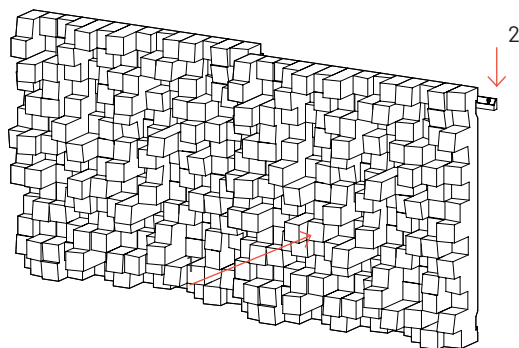
**3D****3E**

**3F**

To install the last Multifuser DC3, use it to mark the inner side of the last fixing clip. Remove the last two panels again and use the gauge provided to ensure the clips are aligned. Fix the last clip. You can use a bubble level to help in this procedure.

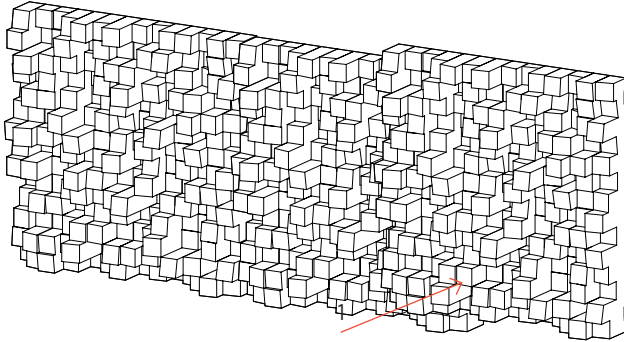
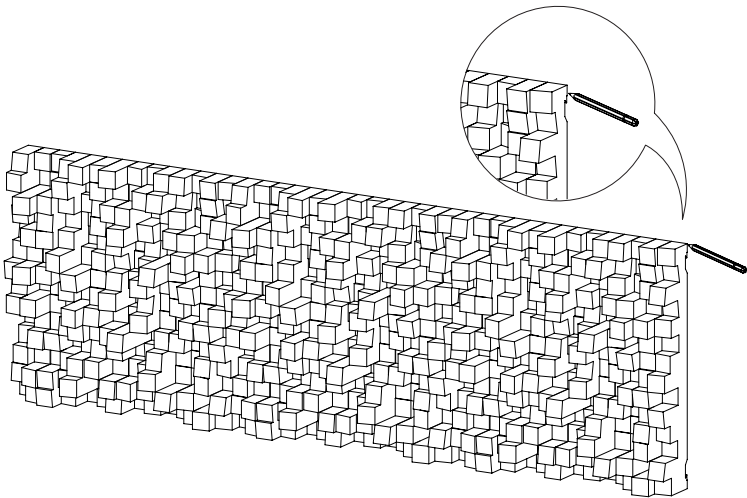
**3G**

3H

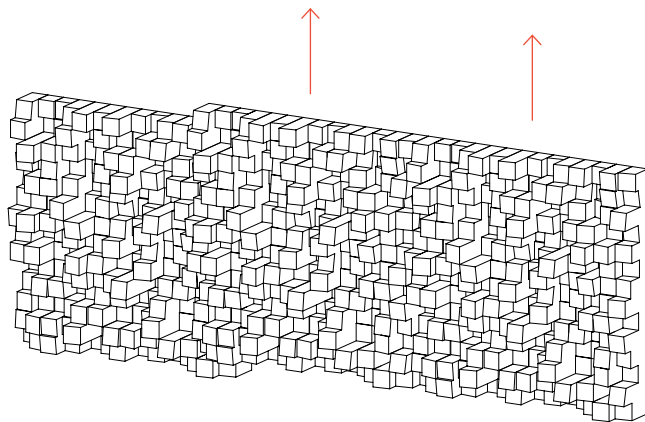

3I

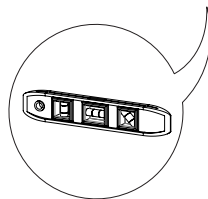
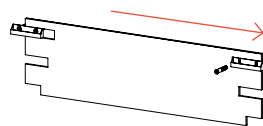
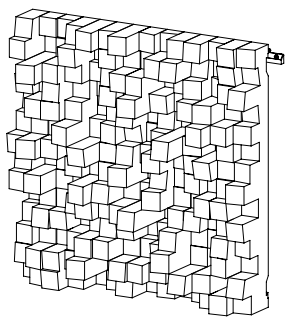



**3J**

Install the last two panels.

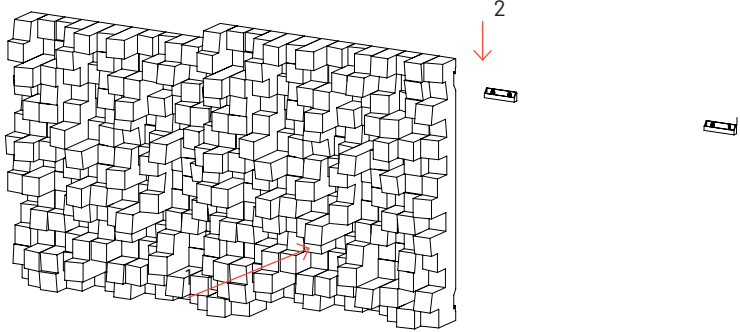
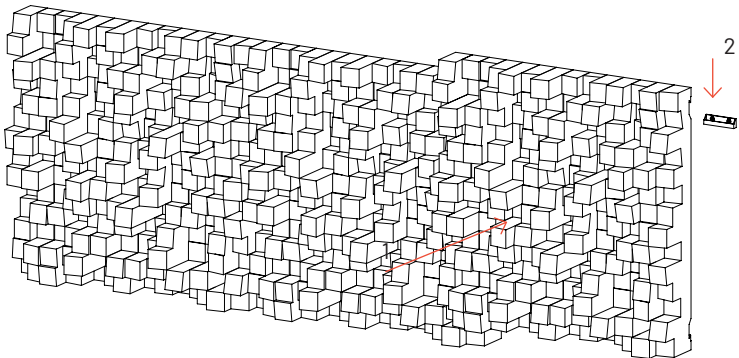
**3L**

# 4

## Wall Installation - Vertical Installation

Install the first panel according to step number 2.  
Follow the steps described in the following diagrams.

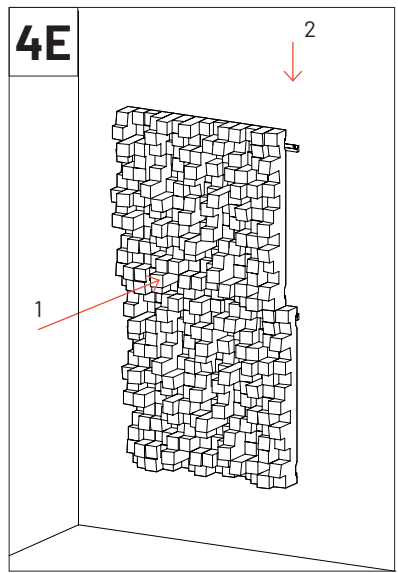
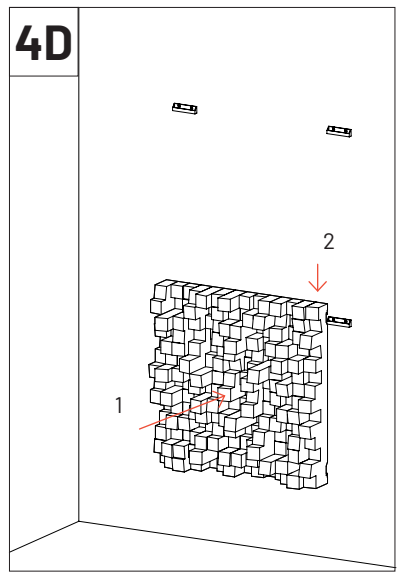
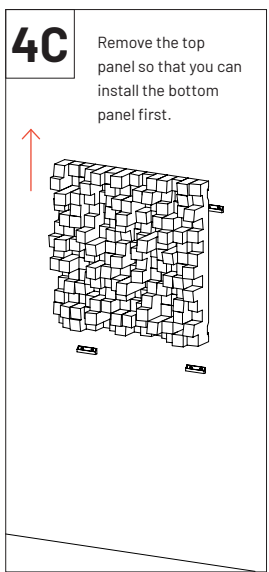
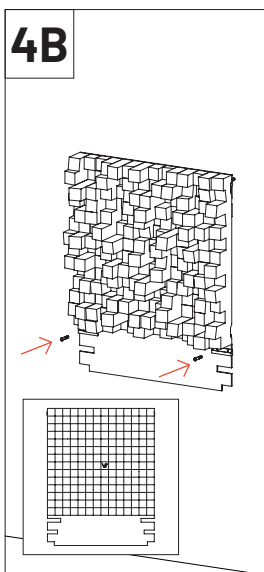
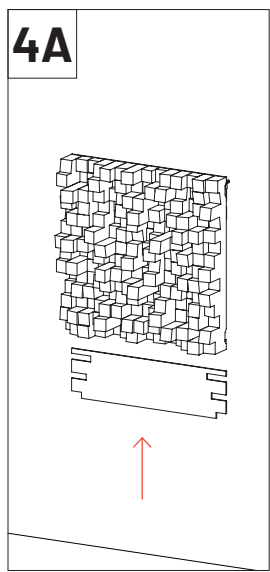

## Ceiling Installation

# 1

Apply the glue on the back of the acoustic panel, near the edges. Do not wait longer than 10 minutes after applying the glue to attach the panel to the wall.

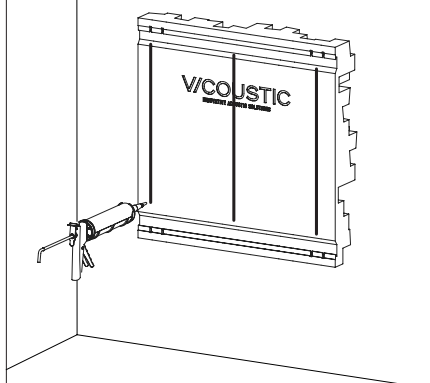

# 2

Place the panel on the suitably chose position on the ceiling. Once in the desired place, press firmly against the wall for 15 seconds.

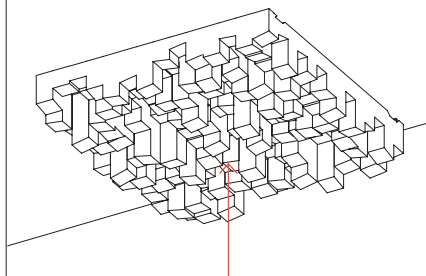

50mm

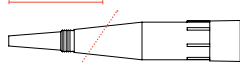

Cut the tip of the glue nozzle according to the diagram.

# !

To ensure that you maximise the strength of the glue, don't make any adjustments to the panel after bonding

Wall and ceiling surfaces should be examined prior to installation, ensuring they are clean, smooth, and dry. If you have unpainted gypsum board surfaces, these should be primed with a drywall primer (or another material manufactured especially for the purpose), to equalize the absorption between the gypsum board face paper, joint compound, and skin coating materials. You should then apply the paint, and allow air circulation in order to dry the paint within the time frame specified by the paint manufacturer. Please ensure the paint is dry before installing the acoustic panel. Make sure the room has all the necessary conditions to receive the acoustic panels. After you apply the glue on the back of each acoustic panel, please ensure you hold the acoustic panel against the wall the required time (mentioned above), and ensure it stays fixed in place. This method is also applicable to ceiling installations.

### **Main Office, R&D & Logistics**

Avenida do Pólo 3, N.º 159, Carvalhosa  
4590-137 Paços de Ferreira, Portugal

### **Office**

Rua Quinta do Bom Retiro N.º 16, Armazém 9  
2820-690 Charneca da Caparica, Portugal  
T (+351) 212 964 100

### **Info and Sales**

E [sales@vicoustic.com](mailto:sales@vicoustic.com)

[www.vicoustic.com](http://www.vicoustic.com)



© Vicoustic, 2021 | V1

No parts of this document might be copied and/or published without written consent of Vicoustic.